

Article number: 3901150100700

Description: Worm gear with solid input shaft
VF 150P-100-HS

Measures

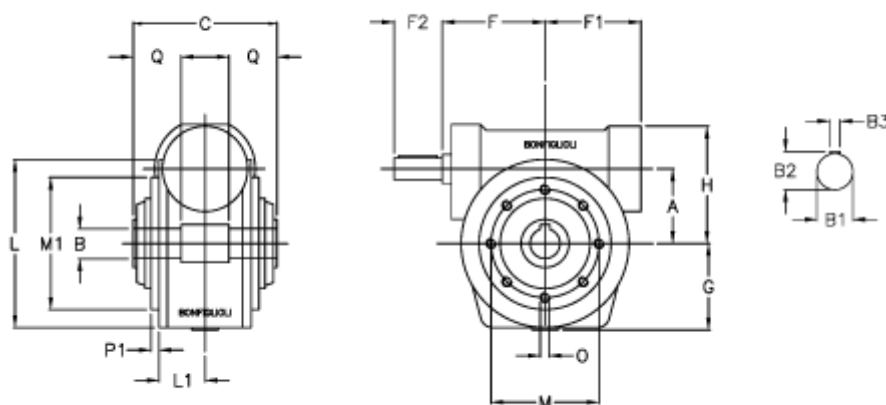

a	= 150.0	F1 = 179	O = M14x23
B	= 50	F2 = 65	P1 = 4.0
B1	= 35	g = 180	Q = 55.0
B2	= 38.0	H = 218	
B3	= 10	L = 250.0	
C	= 175	L1 = 83.5	
Description	= VF 150P-xx-HS	m = 215	
F	= 185.0	M1 = 180	